

# High-pressure thermocouple Model TC90

WIKA data sheet TE 65.90



for further approvals  
see page 6

## Applications

- Plastics-producing industry
- General high-pressure applications

## Special features

- Versions to customer specification
- Various process connections
- Short response times
- Robust, vibration-resistant design
- Various thermocouple types and electrical connection types



High-pressure thermocouple with sealing cone,  
model TC90-C

## Description

This high-pressure thermocouple is used for temperature measurement in industrial applications. The thermocouple is suitable for the highest process requirements and enables reliable temperature measurement, for example, in plastics production and processing.

Each TC90 is designed and manufactured in accordance with individual customer specifications. These instruments are manufactured using special manufacturing processes and, in order to ensure their quality, specific test arrangements and material tests are applied.

This measuring assembly is sealed by means of metal-to-metal sealing, high-pressure threaded connectors or sealing lenses, which have both proven successful over many years.

## Specifications

### Sealing cone materials

- CrNiMo steel 1.6580 (hardened to 30 ... 40 HRC)
- Stainless steel 1.4542

### Process connection

- Conical nipple with male nut
- Conical nipple for slip-on flange
- Sealing cone/lens-type sealing ring

### Thermocouples

- Types K, J, E
- Single, duplex or triplex thermocouple
- Measuring point ungrounded or grounded
- Sheath material, Inconel 600 (2.4816)

## Manufacturing processes

The consistent quality and high pressure containment of the junction between the sheathed cable of the thermocouple and the high-pressure components is ensured through a special automated soldering process.

## Tests and certificates

For a material acceptance test certificate, 3.1 or 3.2 certificates are available for metallic components in accordance with DIN EN 10204. Each model TC90 high-pressure thermocouple is subjected to 1.43 x PN or a hydrostatic pressure test to customer specification, with test pressures to a max. 6,000 bar. Furthermore, for example, liquid penetrant inspection of surfaces or X-ray testing of components are possible in accordance with national or international standards (performance, evaluation).

## Sensors

Although the used thermocouple types (K, J, E) have a much higher measuring range, the maximum operating temperature for high-pressure measurements is limited through the process to 350 °C.

For all characteristic values of the thermocouples, see Technical information IN 00.23.

## Dimensions in mm

### Note:

Each high-pressure thermocouple is designed and manufactured in accordance with individual customer specifications. The specifications contained in the tables are not binding and only constitute examples.

The responsibility for the tolerance and durability of the materials with the medium lies with the operator.

### Model TC90-A, high-pressure thermocouple with male nut

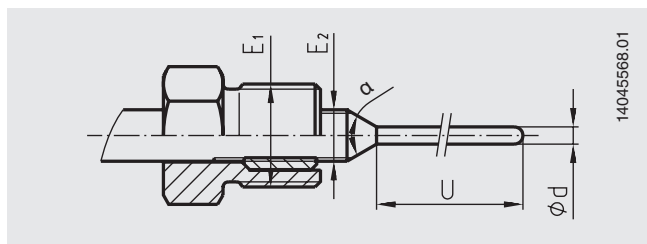

#### Legend:

- E<sub>1</sub> Male nut thread 3/4" - 16 UNF
- E<sub>2</sub> Pressure ring thread 3/8" - 24 UNF LH
- d Thermocouple diameter
- U Insertion length
- α Conical nipple angle

Sealing cone material	Dimensions in mm	
	α	d
CrNiMo steel 1.6580	■ 10°	■ 3.0
	■ 59°	■ 3.17
	■ 60°	■ 4.5
Stainless steel 1.4542	■ 10°	■ 3.0
	■ 59°	■ 3.17
	■ 60°	■ 4.5

### Model TC90-B, high-pressure thermocouple for slip-on flange

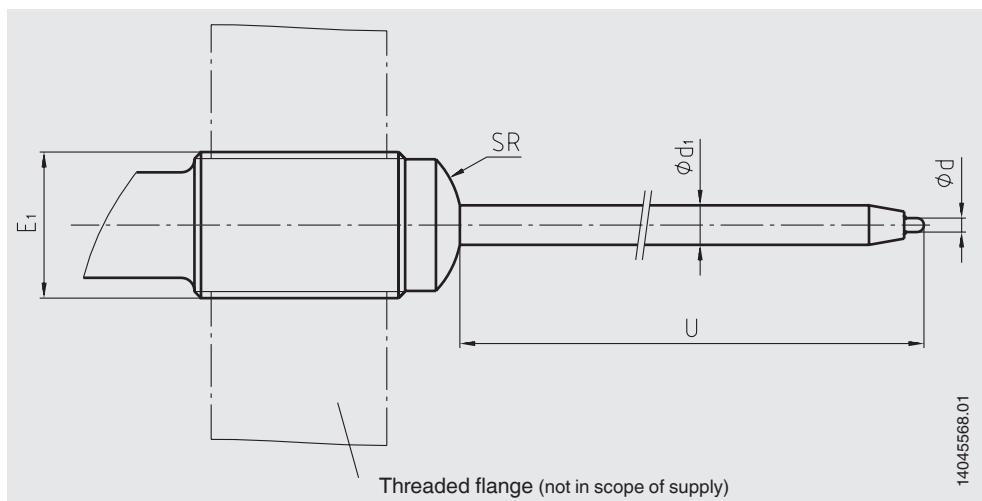

#### Legend:

- E<sub>1</sub> Slip-on flange thread
- d Thermocouple diameter
- U Insertion length
- SR Sealing dome

Sealing cone material	Dimensions in mm			
	SR	E <sub>1</sub>	d	d <sub>1</sub>
CrNiMo steel 1.6580	■ 22	■ G 1 B	■ 3,0	■ 9,0
	■ 35	■ M30 x 2	■ 3,17	■ 9,5
		■ 1 5/8 - 12 UNF	■ 4,5	
		■ 1 3/8 - UNF		
Stainless steel 1.4542	■ 22	■ G 1 B	■ 3,0	■ 9,0
	■ 35	■ M30 x 2	■ 3,17	■ 9,5
		■ 1 5/8 - 12 UNF	■ 4,5	
		■ 1 3/8 - UNF		

**Model TC90-C, high-pressure thermocouple with lens-type sealing ring or sealing cone**

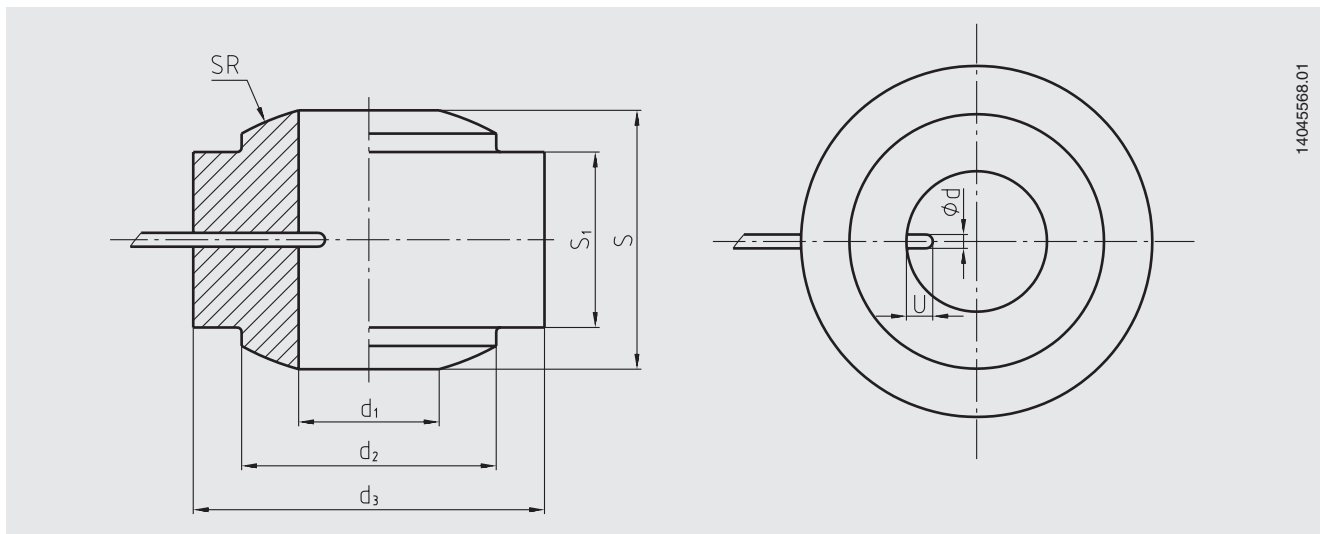

14045668.01

**Legend:**

- d Thermocouple diameter
- U Insertion length <sup>1)</sup>

1) The thermocouple can be mounted flush with the inside diameter of the lens-type sealing ring or cone, without protruding into the process (increased response time).

Lens-type sealing ring/sealing cone to customer requirements or as customer-issued component

Required specifications for manufacturing to customer requirements:

- Inner diameter d<sub>1</sub>
- Lens diameter d<sub>2</sub>
- Outer diameter d<sub>3</sub>
- Edge thickness S<sub>1</sub>
- Thickness S
- Ball radius SR
- Nominal pressure
- Ambient and medium temperature (min/max)
- Loads (overpressure, fluctuating load, vibration. etc.) or other (safety-relevant) conditions (as far as they are known)
- Information about process medium (e.g. abrasive constituents, category in accordance with the PED, state, etc.)

Assembly of the model TC90-C through the incorporation of a thermocouple in customer-issued components:

The scope of delivery for the TC90-C includes the following information on the calculations and tests carried out:

- Calculation of the pressure containment of the soldered joint
- X-ray testing of the thermocouple (optional)
- Test report on pressure test (hydrostatic)
- Test report on heat treatment (if carried out)
- Design in accordance to pressure equipment directive 2014/68/EU

Should additional tests or certificates be required, the operator must notify WIKA of this prior to placing the order.

Sealing cone material	Dimensions in mm
	d
CrNiMo steel 1.6580	■ 3.0
	■ 3.17
	■ 4.5
Stainless steel 1.4542	■ 3.0
	■ 3.17
	■ 4.5

## Connection components

The construction of the connection components for the model TC90 high-pressure thermocouples will be designed in accordance with the customer-specific specification. In general, two variants are used:

- Neck tube with ready-made connection cable
- Neck tube with connection head



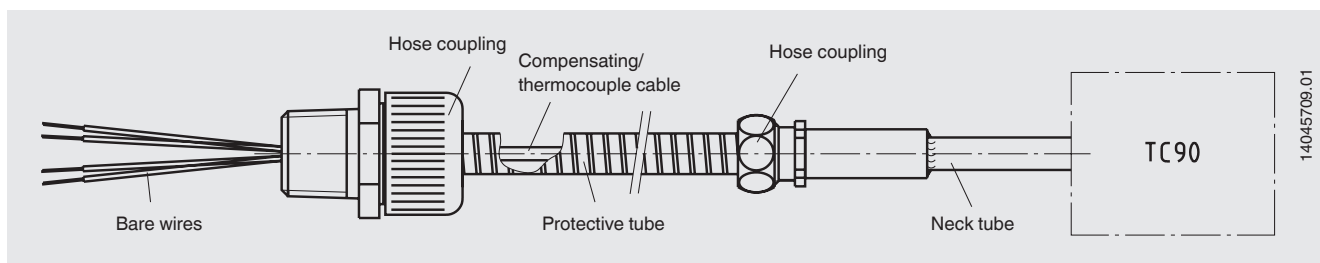



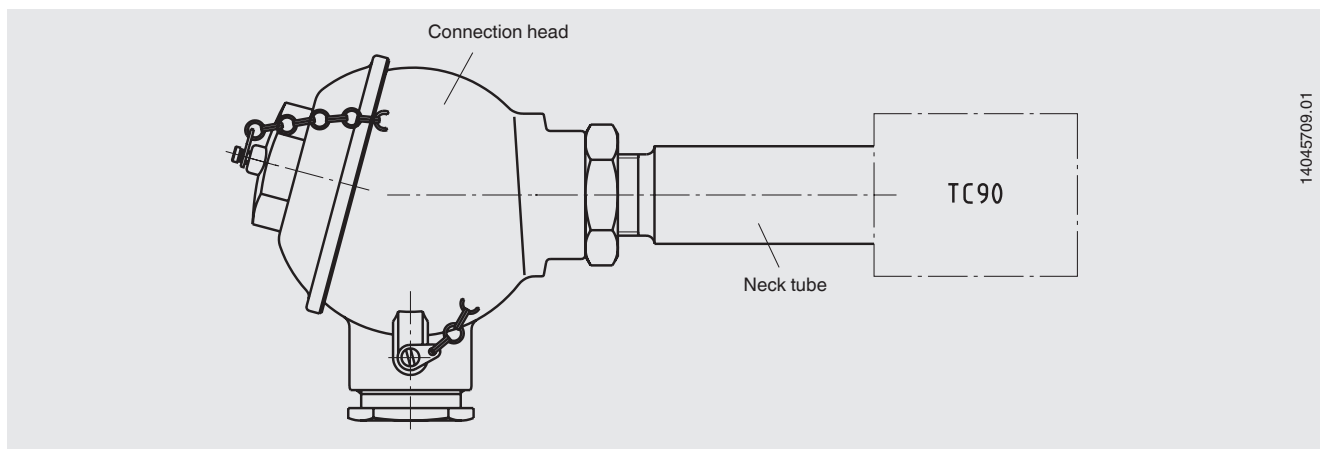



### Example for neck tube with cable outlet



### Example for neck tube with connection head



## Approvals

Logo	Description	Country
	<b>EU declaration of conformity</b> <ul style="list-style-type: none"> <li>■ Pressure equipment directive</li> <li>■ RoHS directive</li> <li>■ ATEX directive (option) Hazardous areas</li> </ul>	European Union
		
	<b>IECEx (option)</b> Hazardous areas	International
	<b>EAC (option)</b> <ul style="list-style-type: none"> <li>■ Pressure equipment directive</li> <li>■ Hazardous areas</li> </ul>	Eurasian Economic Community
	<b>GOST (option)</b> Metrology, measurement technology	Russia
-	<b>MTSCHS (option)</b> Permission for commissioning	Kazakhstan
	<b>BelGIM (option)</b> Metrology, measurement technology	Belarus
	<b>UkrSEPRO (option)</b> Metrology, measurement technology	Ukraine
	<b>INMETRO (option)</b> <ul style="list-style-type: none"> <li>■ Metrology, measurement technology</li> <li>■ Hazardous areas</li> </ul>	Brazil
	<b>NEPSI (option)</b> Hazardous areas	China
	<b>KCs - KOSHA (option)</b> Hazardous areas	South Korea
-	<b>PESO - CCOE (option)</b> Hazardous areas	India

## Certificates (option)

- 2.2 test report
- 3.1 inspection certificate
- DKD/DAkkS calibration certificate

Approvals and certificates, see website

© 03/2014 WIKA Alexander Wiegand SE & Co. KG, all rights reserved.  
 The specifications given in this document represent the state of engineering at the time of publishing.  
 We reserve the right to make modifications to the specifications and materials.

