

## For the plastics machinery industry

### Fixed bayonet thermocouple

### Model TC47-FB

WIKA data sheet TE 67.24

#### Applications

- Plastics and rubber industry
- For direct installation into the process
- Machinery barrel temperature detection
- Dies for extrusion profiles
- Packaging

#### Special features

- The sensor is fixed at a pre-determined length and mounted into the process
- The thermocouple sensors are available with a variety of hold down mechanisms
- Sheath material ranges from stainless steel, corrosion resistant and high temperature oxidation resistant alloys
- Tube and wire construction
- Interchangeable and easily replaceable



Fixed bayonet thermocouple, model TC47-FB

Fig. left: 90° bend version

Fig. centre: 45° bend version

Fig. right: straight version

#### Description

The TC47-FB fixed bayonet thermocouple is a general purpose temperature sensor designed to suit all applications where metal sheathed thermocouples are required. An extensive range of elements and process connections can be individually selected for the appropriate application. With the flexibility of assorted diameters and a pre-determined immersion lengths, the model TC47-FB thermocouple can be used in a wide variety of easily accessible location.

The fixed bayonet cap allows the sensor to have a positive pressure at the tip when installed correctly.

The fixed bayonet, tube and wire design is held in place with a bayonet adapter. They are especially suited for applications where the metal sensor tip is fitted directly into a drilled hole.

The temperature sensor can be modified to suit specific application as required.

## Sensor

### Sensor type

- Type J (Fe-CuNi)
- Type L (Fe-CuNi)
- Type K (NiCr-Ni)
- Type T (CuNi)
- Others on request

### Number of sensors

- 2-wire single circuit
- 4-wire dual circuit

### Classification tolerance

- European Class 1 and 2 per DIN EN 60584-2  
DIN 43714 and DIN 43713: 1991  
International (IEC) DIN 43722: 1994  
JISC 1610: 1981  
NFC 4232  
BS 1843
- North American Class 1 and 2  
ISA standard and special per ANSI MC 96.1 - 1982

### Measuring point

- Isolated (ungrounded)
- Non isolated (grounded)

### Tube and wire construction

The sheath section of the sensor is a tube and wire design. This consists of a stainless steel outer sheath with thermocouple wire drawn through it and secured into place. Due to the construction design and styles, these sensors can be applied in areas that are not difficult to access.

## Options

- Lengths and diameters are customer specified
- Calibration classifications are customer specified
- Tag identification (customer specific identification number)
- Selectable accuracy tolerance
- Mounting options customer specified

## Sensor tip designs

In the standard version a sensor is incorporated which is appropriate for the selected measuring range. Model TC47-FB can be constructed in two different ways:

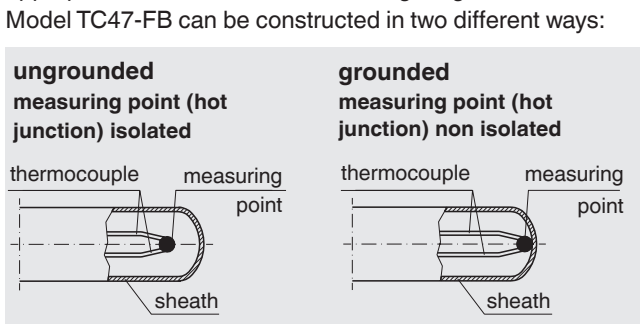

## Basic values and limiting errors

A cold junction temperature of 0 °C is taken as the basis for the definition of the thermocouple's sensor limiting error.

Temperature (ITS 90) °C	Limiting error DIN EN 60584	
	Type J °C	Type K °C
0	± 2.5	± 2.5
200	± 2.5	± 2.5
400	± 3.0	± 3.0
600	± 4.5	± 4.5
800	not defined	± 6.0

### Types J, L DIN EN 60584, ANSI MC 96.1

Class	Temperature range	Limiting error
1	-40 ... +375 °C	± 1.5 °C
1	+375 ... +750 °C	± 0.0040 ·  t  <sup>1)</sup>
2	-40 ... +333 °C	± 2.5 °C
2	+333 ... +750 °C	± 0.0075 ·  t  <sup>1)</sup>

### Type K DIN EN 60584, ANSI MC 96.1

Class	Temperature range	Limiting error
1	-40 ... +375 °C	± 1.5 °C
1	+375 ... +750 °C	± 0.0040 ·  t  <sup>1)</sup>
2	-40 ... +333 °C	± 2.5 °C
2	+333 ... +750 °C	± 0.0075 ·  t  <sup>1)</sup>

### Type T DIN EN 60584, ANSI MC 96.1

Class	Temperature range	Limiting error
1	-40 ... +125 °C	± 0.5 °C
1	+125 ... +350 °C	± 0.0040 ·  t  <sup>1)</sup>
2	-40 ... +133 °C	± 1.0 °C
2	+133 ... +350 °C	± 0.0075 ·  t  <sup>1)</sup>

1) |t| is the value of the temperature in °C without consideration of the sign.

## Sheath material

- Stainless steel
  - up to 1200 °C
  - good corrosion resistance with aggressive media
- Ni-alloy 2.4816 (Inconel 600)
  - standard material for applications which require specific corrosion resistance properties, exposure to high temperatures and resistant to induced stress
- Others on request

## Lead wire

A variety of insulating materials are available to adapt to different prevailing process conditions.

The lead wire termination end can be supplied ready for connection or fitted with a plug as an option.

- Thermocouple, fit to process connection
- Lead extension cross section: min. 0.22 mm<sup>2</sup> (24 awg)
- Insulation material: fibreglass, Kapton, PTFE or PVC
- Other options available

## Operating temperatures

The following temperatures limits apply to the conventional connecting lead wire.

- Fibreglass -50 ... +482 °C
- Kapton -25 ... +260 °C
- PTFE -50 ... +260 °C
- PVC -20 ... +105 °C

### Kapton / Kapton

500 °F (260 °C)  
Polyimide tape insulation for improved electrical properties and high temperature applications.



500 °F (260 °C)  
Polyimide tape jacket for excellent abrasion and cut through properties and very high resistance to moisture and chemicals.

### Fibreglass / Fibreglass

900 °F (482 °C)  
Wrapped fibreglass insulation for improved moisture and abrasion resistance at high temperatures.



900 °F (482 °C)  
Braided fibreglass for additional flexibility and abrasion resistance at high temperatures.

### PVC / PVC

221 °F (105 °C)  
PVC insulation for economy, durability and mechanical strength



221 °F (105 °C)  
PVC jacket for economy, durability and mechanical strength. It is also tough and resistant to flame, abrasion and moisture.

### PTFE / PTFE

500 °F (260 °C)  
PFA insulation for improved electrical properties and high temperature applications.



500 °F (260 °C)  
PFA jacket for chemical inertness to solvents, acids and oils.

## Process connections

The thermocouple is fitted with a bayonet cap that is customer specific. These various caps are individually specified.

## Lead wire coverings

### ■ Stainless steel overbraid (no tracer)

Stainless steel overbraid is by far the most common of the overbraids and is available on almost all thermocouples and extension duplex wire constructions. While highly resistant to corrosion, stainless steel is able to maintain a continuous operating temperature of 1400 °F (760 °C).



### ■ Stainless steel overbraid (with tracer)

Resembles stainless steel with a colour coded fibre tracer identifying the calibration type with minimum braid coverage of 85 %.



### ■ Tinned copper overbraid

Although similar in some characteristics to stainless steel, is a more economical alternative. This product offers an improved feature of shielding against static noise (if it is properly insulated and grounded) with a continuous operating temperature of 400 °F (204 °C).



### ■ Interlocking flexible stainless steel armour

Is a half oval armour applied in a spiral wrap fashion. In addition to having similar characteristics to the overbraids, stainless steel armour maintains better crush and piercing resistant properties. It can operate in higher temperature 1400 °F (760 °C). This covering is a non-magnetic corrosive, and piercing resistant shield. Resistant to rusting in outdoor applications.



## Plug (option)

TC47-FB thermocouple can be supplied with plugs attached to the conductors.

The maximum permissible temperature at the plug is 85 °C.

The following options are available:

### ■ Spade lugs

(not suitable for versions with bare connecting wires)

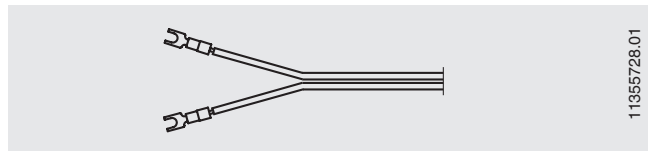

### ■ Screw-in-plug, Binder (male)

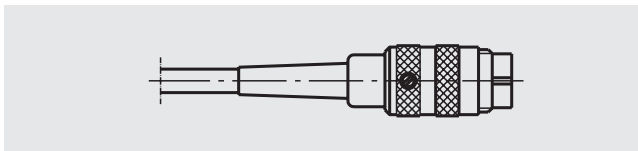

### ■ Lemosa plug size 1 S (male)

### ■ Lemosa plug size 2 S (male)

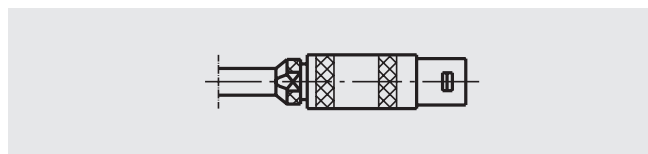

### ■ Screw-in-plug, Binder (female)

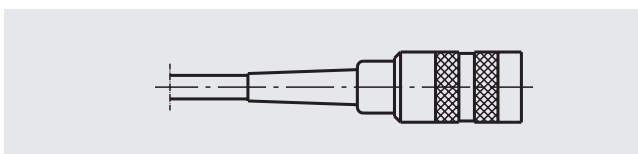

### ■ Lemosa plug size 1 S (female)

### ■ Lemosa plug size 2 S (female)

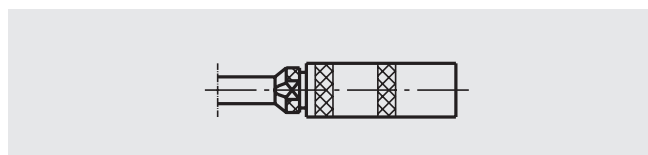

### ■ Standard thermo plug 2-pin (male)

### ■ Miniature thermo plug 2-pin (male)

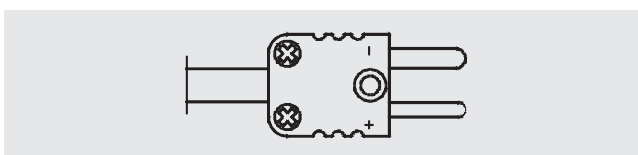

### ■ Standard cable clamp (option with thermo plug)

### ■ Miniature cable clamp (option with thermo plug)

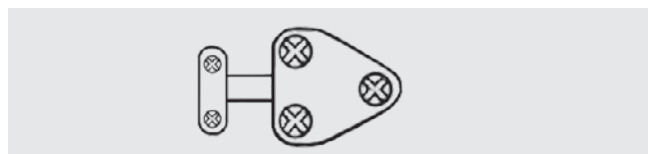

### ■ Standard thermo plug 2-pin (female)

### ■ Miniature thermo plug 2-pin (female)

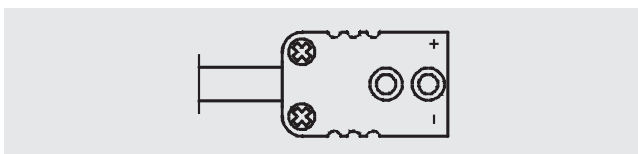

# Electrical connection

	Cable 3171966.01	Lemosa plug, (male) on cable 3374896.01	Binder plug (series 680), (male) on cable (screw-in-plug) 3374900.02
	Colour codes of the wire ends see table below		
Single thermocouple			
Dual thermocouple			
Thermo plug		Positive and negative terminal are marked. Two thermo connectors are used with dual thermocouples.	

Other connector plugs and pin assignments on request.

## Thermocouple and extension wire colour codes

National Standard	ANSI MC 96.1 T/C Grade	ANSI MC 96.1 Extension Grade	BS 1843	DIN 43714	ISC1610-198	NF C42-323	IEC 584-3 T/C Grade	IEC 584-3 Intrinsically Safe
N				No Standard Use ANSI Colour Codes	No Standard Use ANSI Colour Codes	No Standard Use ANSI Colour Codes		
J								
K								
E								
T								
R	None Established							
S	None Established							
B	None Established		No Standard Use Copper Wire			No Standard Use Copper Wire		

## Thermocouple tolerances (cold junction temperature at 0 °C)

IEC tolerance values per EN 60584-2				
Thermocouple type		Tolerance class 1	Tolerance class 2	Tolerance class 3
T	Temperature range	-40 ... +125 °C	-40 ... +133 °C	-67 ... +40 °C
	Tolerance value	±0.5 °C	±1.0 °C	±1.0 °C
	Temperature range	+125 ... +350 °C	+133 ... +350 °C	-200 ... -67 °C
	Tolerance value	±0.004 ltl	±0.0075 ltl	±0.015 ltl
J	Temperature range	-40 ... 375 °C	-40 ... +333 °C	-
	Tolerance value	±1.5 °C	±2.5 °C	-
	Temperature range	+375 ... +750 °C	+333 ... +750 °C	-
	Tolerance value	±0.004 ltl	±0.0075 ltl	-
E	Temperature range	-40 ... +375 °C	-40 ... +333 °C	-167 ... +40 °C
	Tolerance value	±1.5 °C	±2.5 °C	±2.5 °C
	Temperature range	+375 ... +800 °C	+333 ... +900 °C	-200 ... -167 °C
	Tolerance value	±0.004 ltl	±0.0075 ltl	±0.015 ltl
K or N	Temperature range	-40 ... +375 °C	+40 ... +333 °C	-167 ... +40 °C
	Tolerance value	±1.5 °C	±2.5 °C	±2.5 °C
	Temperature range	+375 ... +1000 °C	+333 ... +1200 °C	-200 ... -167 °C
	Tolerance value	±0.004 ltl	±0.0075 ltl	±0.015 ltl
R or S	Temperature range	0 ... +1100 °C	0 ... +600 °C	-
	Tolerance value	±1.0 °C	±1.5 °C	-
	Temperature range	+1100 ... +1600 °C	+600 ... +1600 °C	-
	Tolerance value	±[1 + 0.003 (t-1100)]	±0.0025 ltl	-
B	Temperature range	-	-	+600 ... +800 °C
	Tolerance value	-	-	+4.0 °C
	Temperature range	-	+600 ... +1700 °C	+800 ... +1700 °C
	Tolerance value	-	±0.0025 ltl	+0.005 ltl

ASTM tolerance values (ASTM E230)					
Thermocouple type		Standard limits (whichever value is greater)		Special limits (whichever value is greater)	
T	Temperature range	0 ... +370 °C	+32 ... +700 °F	0 ... +370 °C	+32 ... +700 °F
	Tolerance value	±1 °C or ±0.75 %	±1.8 °F or ±0.75 %	±0.5 °C or 0.4 %	±0.9 °F or 0.4 %
	Temperature range	-200 ... 0 °C	-328 ... 32 °F	-	-
	Tolerance value	±1.0 °C or ±1.5 %	±1.8 °F or ±1.5 %	-	-
J	Temperature range	0 ... +760 °C	+32 ... +1400 °F	0 ... +760 °C	+32 ... +1400 °F
	Tolerance value	±2.2 °C or ±0.75 %	±4.0 °F or ±0.75 %	±1.1 °C or 0.4 %	±2.0 °F or 0.4 %
E	Temperature range	0 ... +870 °C	+32 ... +1600 °F	0 ... +870 °C	+32 ... +1600 °F
	Tolerance value	±1.7 °C or ±0.5 %	±3.1 °F or ±0.5 %	±1.0 °C or ±0.4 %	±1.8 °F or ±0.4 %
	Temperature range	-200 ... 0 °C	-328 ... 32 °F	-	-
	Tolerance value	±1.7 °C or ±1.0 %	±3.1 °F or ±1.0 %	-	-
K	Temperature range	0 ... +1260 °C	+32 ... +2300 °F	0 ... +1260 °C	+32 ... +2300 °F
	Tolerance value	±2.2 °C or ±0.75 %	±4.0 °F or ±0.75 %	±1.1 °C or ±0.4 %	±2.0 °F or ±0.4 %
	Temperature range	-200 ... 0 °C	-328 ... 32 °F	-	-
	Tolerance value	±2.2 °C or ±2.0 %	±4.0 °F or ±2.0 %	-	-
N	Temperature range	0 ... +1260 °C	+32 ... +2300 °F	0 ... +1260 °C	+32 ... +2300 °F
	Tolerance value	±2.2 °C or ±0.75 %	±4.0 °F or ±0.75 %	±1.1 °C or ±0.4 %	±2.0 °F or ±0.4 %
R or S	Temperature range	0 ... +1480 °C	+32 ... +2700 °F	0 ... +1480 °C	+32 ... +2700 °F
	Tolerance value	±1.5 °C or ±0.25 %	±2.7 °F or ±0.25 %	±0.6 °C or ±0.1 %	±1.1 °F or ±0.1 %
B	Temperature range	+870 ... 1700 °C	+1600 ... +3100 °F	+870 ... 1700 °C	+1600 ... +3100 °F
	Tolerance value	±0.5 %	±0.5 %	±0.25 %	±0.25 %



## Ordering information

The fixed bayonet thermocouple is preset to a preferred length. The junction tip is submersed into a pre-determined bore. The fixed thermocouple senses temperature at the bottom of the bored hole. This style is held into position with a bayonet adapter.



When ordering choose from each category.

### Fixed bayonet version

- Straight
- 45° bend
- 90° bend

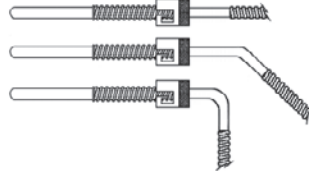

### Junction

- Grounded (unisolated)
- Ungrounded (isolated)

### Probe diameter

- 3/16"
- 1/4"
- 3/8"
- 4 mm
- 6 mm
- 8 mm
- Others on request

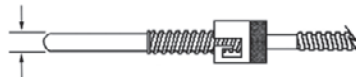

### Probe length

- Specify length (in mm)

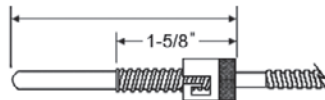

### Bayonet cap Id Ø Fits bayonet adapter

- |                     |                  |            |
|---------------------|------------------|------------|
| ■ Single slot       | 11.4 mm (7/16")  | 11 mm O.D. |
| ■ Double slot       | 11.4 mm (7/16")  | 11 mm O.D. |
| ■ Double slot       | 12.2 mm (31/64") | 12 mm O.D. |
| ■ Double slot       | 14.2 mm (9/16")  | 12 mm O.D. |
| ■ Double slot       | 15.2 mm (19/32") | 15 mm O.D. |
| ■ Others on request |                  |            |

### Lead length

- 500 mm
- 1000 mm
- 1500 mm
- 2000 mm
- 2500 mm
- Others on request

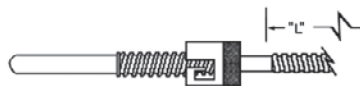

### Lead wire

- Fibreglass / fibreglass
- PTFE / PTFE
- PVC / PVC
- Kapton / Kapton
- Others on request

### Lead wire covering

- None
- Stainless steel overbraid (no tracer)
- Stainless steel overbraid (with tracer)
- Tin copper overbraid
- Interlocking flexible armour

### Termination at lead end

- Bare ends
- Standard thermo plug 2-pin (male)
- Miniature thermo plug 2-pin (male)
- Standard plug with cable clamp (male)
- Miniature plug with cable clamp (male)
- Lemosa plug size 1S (male)
- Lemosa plug size 2S (male)
- Screw-in plug, Binder (male)
- Others on request

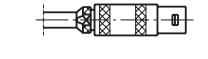
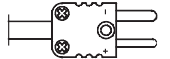

### Calibration type

- |                     |             |         |          |
|---------------------|-------------|---------|----------|
| ■ J                 | ANSI MC96.1 | red ⊖   | white ⊕  |
| ■ K                 | ANSI MC96.1 | red ⊖   | yellow ⊕ |
| ■ T                 | ANSI MC96.1 | red ⊖   | blue ⊕   |
| ■ J                 | IEC 584-3   | white ⊖ | black ⊕  |
| ■ K                 | IEC 584-3   | white ⊖ | green ⊕  |
| ■ T                 | IEC 584-3   | white ⊖ | brown ⊕  |
| ■ J                 | DIN 43714   | blue ⊖  | red ⊕    |
| ■ K                 | DIN 43714   | green ⊖ | red ⊕    |
| ■ T                 | DIN 43714   | brown ⊖ | red ⊕    |
| ■ Others on request |             |         |          |

© 2011 WIKA Alexander Wiegand SE & Co. KG, all rights reserved.  
The specifications given in this document represent the state of engineering at the time of publishing.  
We reserve the right to make modifications to the specifications and materials.

